

	PROJECT: PAU ASSOCIATES LTD TOWNSHIP OF MIDDLETON, MIDDLETON COUNTY, NEW JERSEY		DYNAMIC ENGINEERING 520 Newtown Yardley Road, Suite 201 Newtown, PA 18940 TEL: 717-854-8511 FAX: 717-854-8511 OFFICE: 717-854-8511	STEVEN R. CATTANI PROFESSIONAL ENGINEER NO. 00000000000000000000
	SHEET NO. 26 OF 26			BRETT W. SKAPINEZ PROFESSIONAL ENGINEER NO. 00000000000000000000

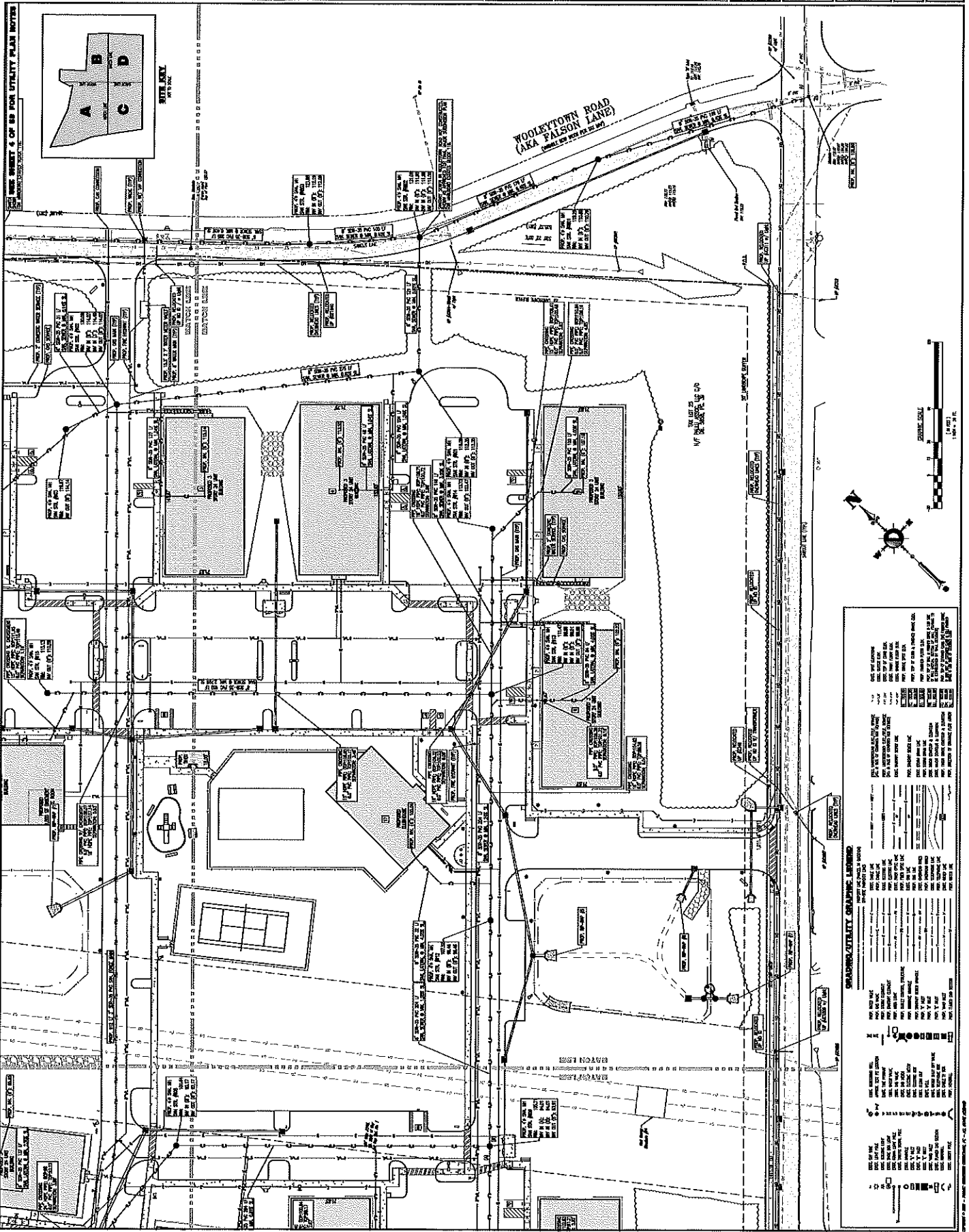

SYMBOLS AND GRAPHIC LEGEND

	12" WATER MAIN
	18" WATER MAIN
	24" WATER MAIN
	30" WATER MAIN
	36" WATER MAIN
	42" WATER MAIN
	48" WATER MAIN
	54" WATER MAIN
	60" WATER MAIN
	66" WATER MAIN
	72" WATER MAIN
	78" WATER MAIN
	84" WATER MAIN
	90" WATER MAIN
	96" WATER MAIN
	102" WATER MAIN
	108" WATER MAIN
	114" WATER MAIN
	120" WATER MAIN
	126" WATER MAIN
	132" WATER MAIN
	138" WATER MAIN
	144" WATER MAIN
	150" WATER MAIN
	156" WATER MAIN
	162" WATER MAIN
	168" WATER MAIN
	174" WATER MAIN
	180" WATER MAIN
	186" WATER MAIN
	192" WATER MAIN
	198" WATER MAIN
	204" WATER MAIN
	210" WATER MAIN
	216" WATER MAIN
	222" WATER MAIN
	228" WATER MAIN
	234" WATER MAIN
	240" WATER MAIN
	246" WATER MAIN
	252" WATER MAIN
	258" WATER MAIN
	264" WATER MAIN
	270" WATER MAIN
	276" WATER MAIN
	282" WATER MAIN
	288" WATER MAIN
	294" WATER MAIN
	300" WATER MAIN
	306" WATER MAIN
	312" WATER MAIN
	318" WATER MAIN
	324" WATER MAIN
	330" WATER MAIN
	336" WATER MAIN
	342" WATER MAIN
	348" WATER MAIN
	354" WATER MAIN
	360" WATER MAIN
	366" WATER MAIN
	372" WATER MAIN
	378" WATER MAIN
	384" WATER MAIN
	390" WATER MAIN
	396" WATER MAIN
	402" WATER MAIN
	408" WATER MAIN
	414" WATER MAIN
	420" WATER MAIN
	426" WATER MAIN
	432" WATER MAIN
	438" WATER MAIN
	444" WATER MAIN
	450" WATER MAIN
	456" WATER MAIN
	462" WATER MAIN
	468" WATER MAIN
	474" WATER MAIN
	480" WATER MAIN
	486" WATER MAIN
	492" WATER MAIN
	498" WATER MAIN
	504" WATER MAIN
	510" WATER MAIN
	516" WATER MAIN
	522" WATER MAIN
	528" WATER MAIN
	534" WATER MAIN
	540" WATER MAIN
	546" WATER MAIN
	552" WATER MAIN
	558" WATER MAIN
	564" WATER MAIN
	570" WATER MAIN
	576" WATER MAIN
	582" WATER MAIN
	588" WATER MAIN
	594" WATER MAIN
	600" WATER MAIN
	606" WATER MAIN
	612" WATER MAIN
	618" WATER MAIN
	624" WATER MAIN
	630" WATER MAIN
	636" WATER MAIN
	642" WATER MAIN
	648" WATER MAIN
	654" WATER MAIN
	660" WATER MAIN
	666" WATER MAIN
	672" WATER MAIN
	678" WATER MAIN
	684" WATER MAIN
	690" WATER MAIN
	696" WATER MAIN
	702" WATER MAIN
	708" WATER MAIN
	714" WATER MAIN
	720" WATER MAIN
	726" WATER MAIN
	732" WATER MAIN
	738" WATER MAIN
	744" WATER MAIN
	750" WATER MAIN
	756" WATER MAIN
	762" WATER MAIN
	768" WATER MAIN
	774" WATER MAIN
	780" WATER MAIN
	786" WATER MAIN
	792" WATER MAIN
	798" WATER MAIN
	804" WATER MAIN
	810" WATER MAIN
	816" WATER MAIN
	822" WATER MAIN
	828" WATER MAIN
	834" WATER MAIN
	840" WATER MAIN
	846" WATER MAIN
	852" WATER MAIN
	858" WATER MAIN
	864" WATER MAIN
	870" WATER MAIN
	876" WATER MAIN
	882" WATER MAIN
	888" WATER MAIN
	894" WATER MAIN
	900" WATER MAIN
	906" WATER MAIN
	912" WATER MAIN
	918" WATER MAIN
	924" WATER MAIN
	930" WATER MAIN
	936" WATER MAIN
	942" WATER MAIN
	948" WATER MAIN
	954" WATER MAIN
	960" WATER MAIN
	966" WATER MAIN
	972" WATER MAIN
	978" WATER MAIN
	984" WATER MAIN
	990" WATER MAIN
	996" WATER MAIN
	1002" WATER MAIN
	1008" WATER MAIN
	1014" WATER MAIN
	1020" WATER MAIN
	1026" WATER MAIN
	1032" WATER MAIN
	1038" WATER MAIN
	1044" WATER MAIN
	1050" WATER MAIN
	1056" WATER MAIN
	1062" WATER MAIN
	1068" WATER MAIN
	1074" WATER MAIN
	1080" WATER MAIN
	1086" WATER MAIN
	1092" WATER MAIN
	1098" WATER MAIN
	1104" WATER MAIN
	1110" WATER MAIN
	1116" WATER MAIN
	1122" WATER MAIN
	1128" WATER MAIN
	1134" WATER MAIN
	1140" WATER MAIN
	1146" WATER MAIN
	1152" WATER MAIN
	1158" WATER MAIN
	1164" WATER MAIN
	1170" WATER MAIN
	1176" WATER MAIN
	1182" WATER MAIN
	1188" WATER MAIN
	1194" WATER MAIN
	1200" WATER MAIN
	1206" WATER MAIN
	1212" WATER MAIN
	1218" WATER MAIN
	1224" WATER MAIN
	1230" WATER MAIN
	1236" WATER MAIN
	1242" WATER MAIN
	1248" WATER MAIN
	1254" WATER MAIN
	1260" WATER MAIN
	1266" WATER MAIN
	1272" WATER MAIN
	1278" WATER MAIN
	1284" WATER MAIN
	1290" WATER MAIN
	1296" WATER MAIN
	1302" WATER MAIN
	1308" WATER MAIN
	1314" WATER MAIN
	1320" WATER MAIN
	1326" WATER MAIN
	1332" WATER MAIN
	1338" WATER MAIN
	1344" WATER MAIN
	1350" WATER MAIN
	1356" WATER MAIN
	1362" WATER MAIN
	1368" WATER MAIN
	1374" WATER MAIN
	1380" WATER MAIN
	1386" WATER MAIN
	1392" WATER MAIN
	1398" WATER MAIN
	1404" WATER MAIN
	1410" WATER MAIN
	1416" WATER MAIN
	1422" WATER MAIN
	1428" WATER MAIN
	1434" WATER MAIN
	1440" WATER MAIN
	1446" WATER MAIN
	1452" WATER MAIN
	1458" WATER MAIN
	1464" WATER MAIN
	1470" WATER MAIN
	1476" WATER MAIN
	1482" WATER MAIN
	1488" WATER MAIN
	1494" WATER MAIN
	1500" WATER MAIN

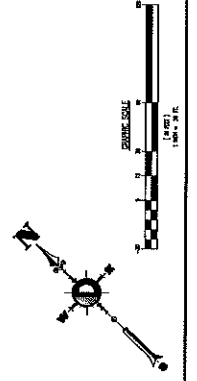

	PROJECT: PALM ASSOCIATES, LTD. 10000 PALM BLVD., SUITE 200 PALM BEACH, FL 33411	DATE: 08/20/08 DRAWN BY: SMC CHECKED BY: SMC	SHEET NO. 30 OF 30
	FOR THE CITY OF PALM BEACH COUNTY, FLORIDA PROJECT: STORM PROFILES LOCATION: 10000 PALM BLVD., SUITE 200, PALM BEACH, FL 33411		SCALE: 1" = 10' DATE: 08/20/08

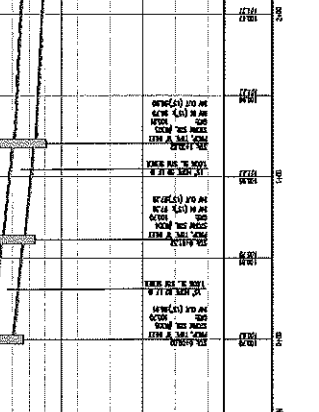
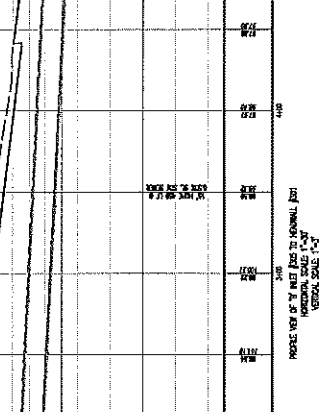
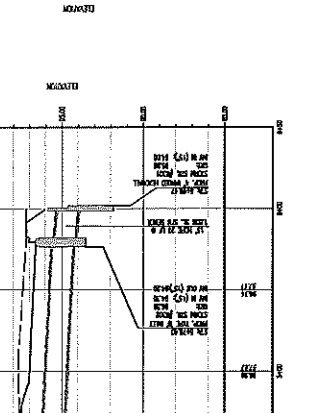
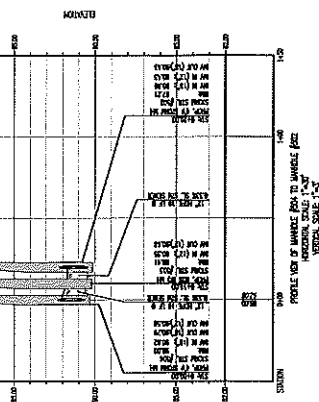
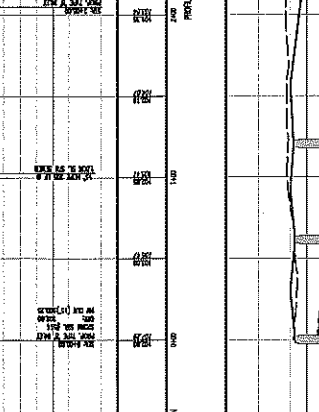
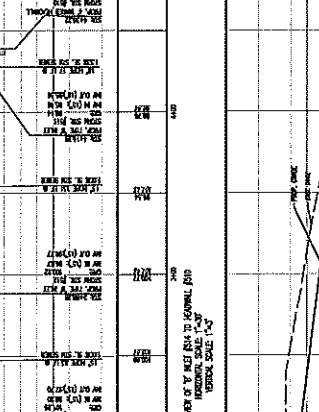
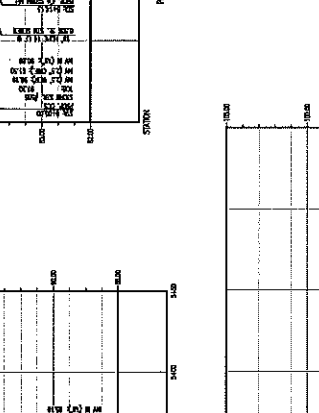
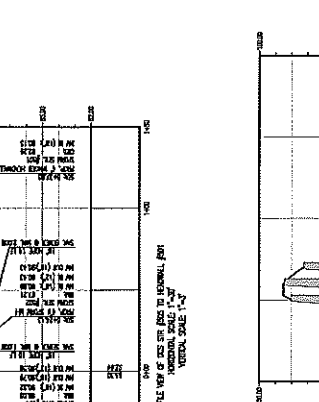
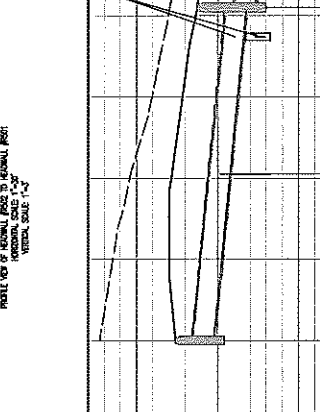
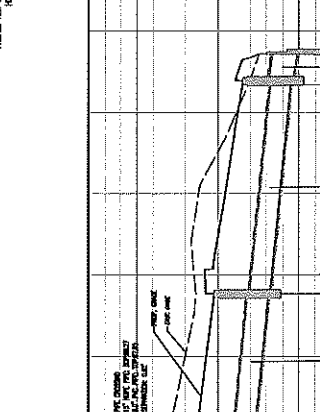
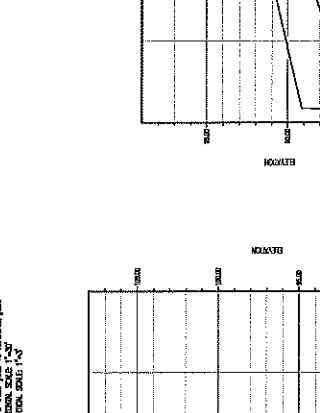
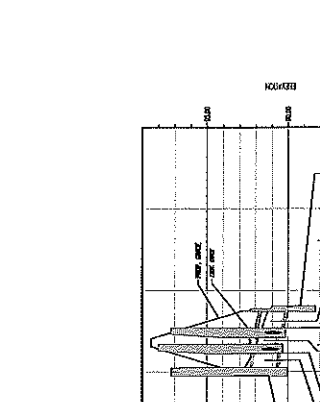
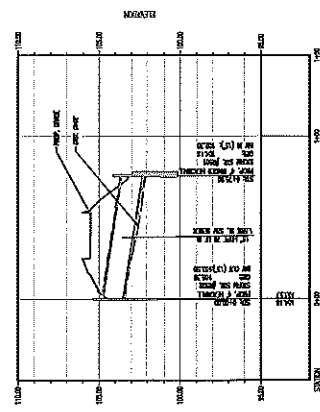
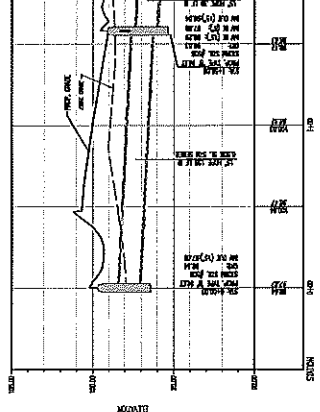
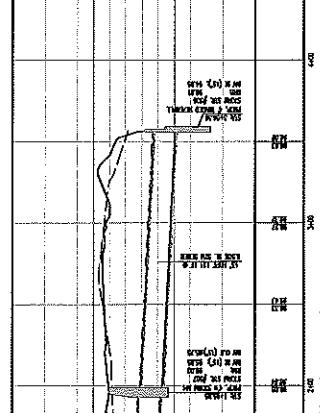
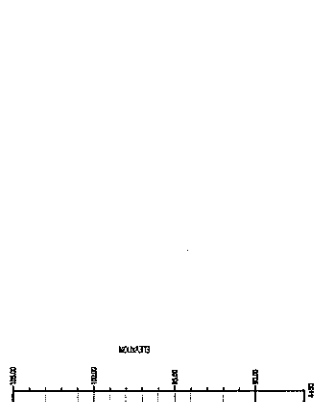



DYNAMIC ENGINEERING

NO.	DATE	REVISION

FOR THE SPECIAL DISTRICT OF THE DISTRICT OF COLUMBIA
 PROJECT: **PALM ASSOCIATES, LLC**
 TRACT: **TRACT 1000**
 LOCATION: **TRACT 1000**
 SHEET: **32**



DYNAMIC ENGINEERING
 228 New York Turnpike Road,
 Suite 201
 New York, NY 10964
 TEL: 212-490-1100
 FAX: 212-490-1101
 WWW.DYNAMICENGINEERING.COM

STEVEN R. CATRANI
 PROJECT MANAGER
 212-490-1100

BRETT W. SKAPINEZ
 PROJECT MANAGER
 212-490-1100

SANITARY PROFILES

DATE: 11/17/23
 SHEET NO: 32
 OF 32

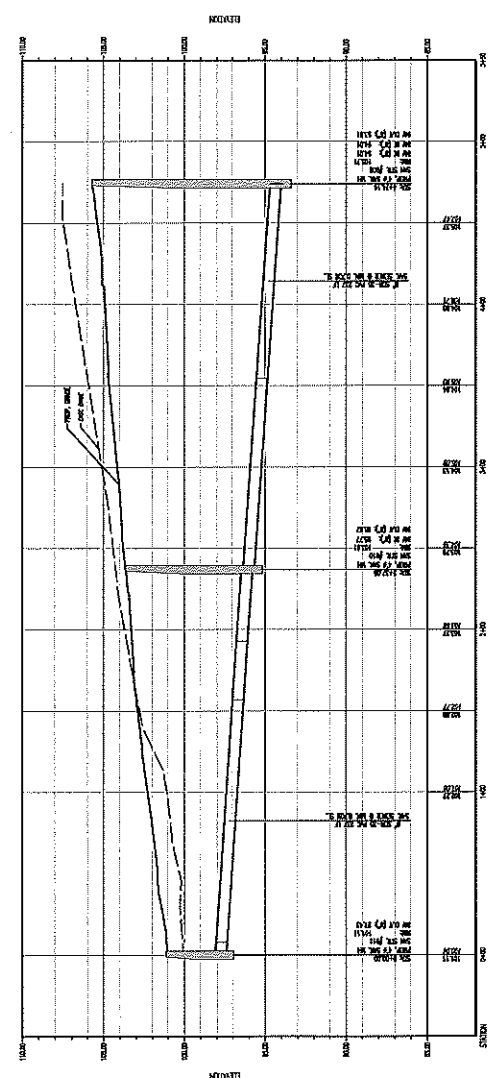
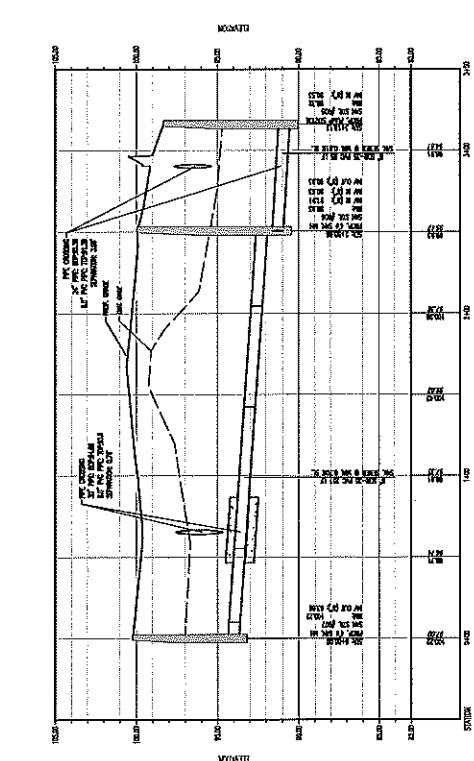
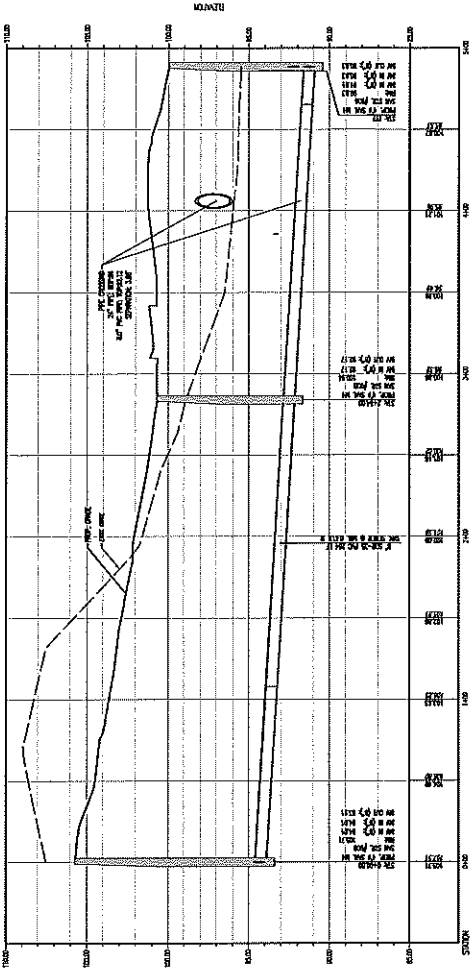



PROJECT	PHASE	DATE	BY
TRUCK STOP	1	11/17/20	STW
CLIENT	NO. 1	NO. 2	NO. 3
NO. 1	NO. 2	NO. 3	NO. 4
NO. 5	NO. 6	NO. 7	NO. 8
NO. 9	NO. 10	NO. 11	NO. 12
NO. 13	NO. 14	NO. 15	NO. 16
NO. 17	NO. 18	NO. 19	NO. 20

THIS PLAN IS FOR LIGHTING PURPOSES ONLY. SEE SHEET 48 OF 48 FOR LIGHTING PLAN NOTES. THIS PLAN IS FOR GRAPHICAL REPRESENTATION PURPOSES ONLY. NOT FOR CONSTRUCTION.

PAUL ASSOCIATES, LTD.
TRUCK STOP, 11000 W. WILSON ROAD, SUITE 100, FALGON, TX 75125
TEL: 972.241.1111 FAX: 972.241.1112
WWW.PAULASSOCIATES.COM

DYNAMIC ENGINEERING
INTERNATIONAL CORPORATION
526 Newlin-Carley Road, Suite 201
Newlin, PA 17140
TEL: 717.463.7111 FAX: 717.463.7112
WWW.DYNAMICENGINEERING.COM

STEVEN R. CATTANI
REGISTERED PROFESSIONAL ENGINEER
NO. 11111

BRETT W. SAPPNETZ
REGISTERED PROFESSIONAL ENGINEER
NO. 11111

OVERALL LIGHTING PLAN

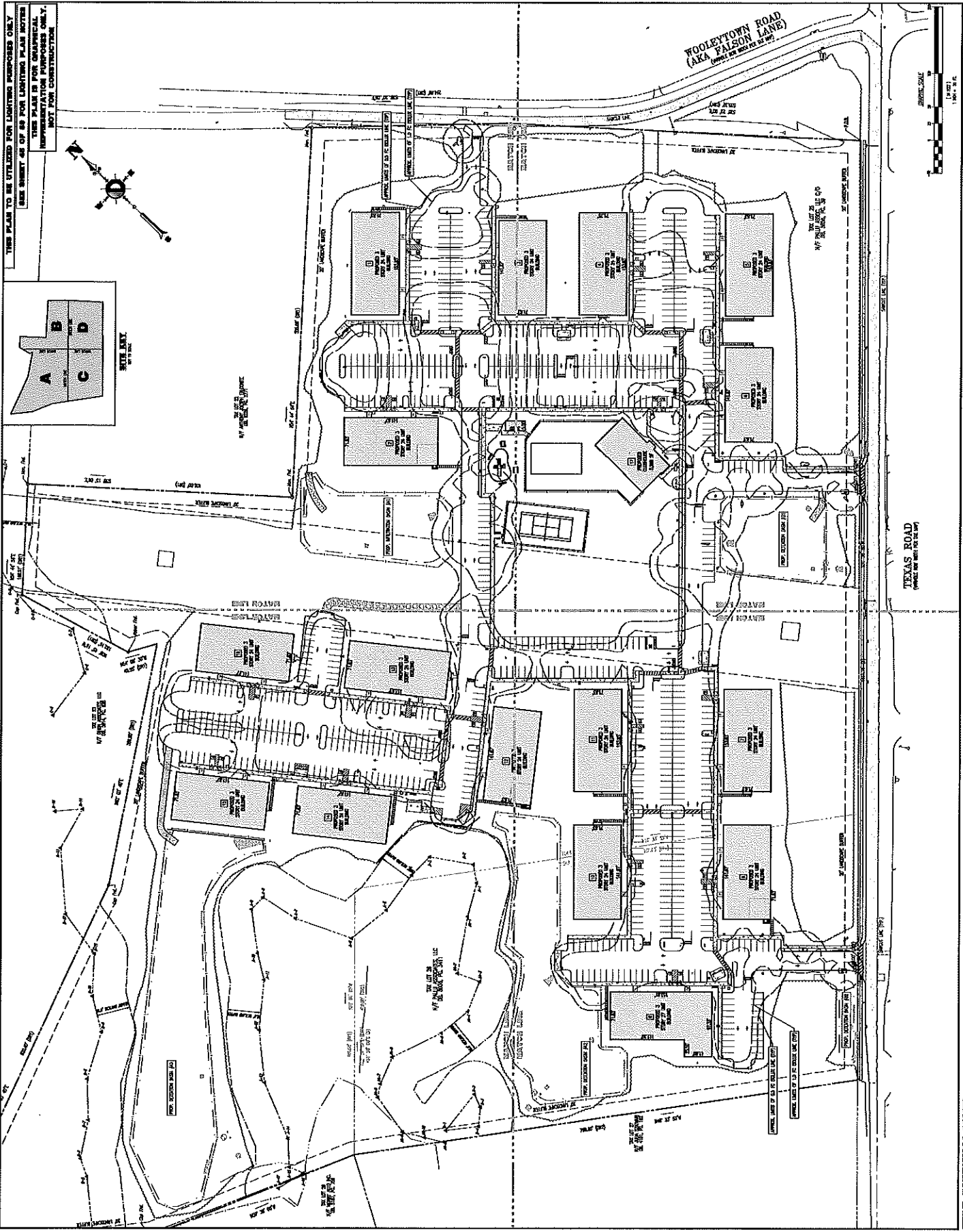



TEXAS ROAD (PROJECT AND NOT FOR THE PLAN)

FOLLEYTOWN ROAD (AKA FALSON LANE) (PROJECT AND NOT FOR THE PLAN)

GRAPHIC SCALE
1" = 100'
1/8" = 10'

40

	PROJECT: PAVING ASSOCIATES, LTD. 1000 WEST 10TH AVENUE, SUITE 100 DENVER, COLORADO 80202		DYNAMIC ENGINEERING 825 Newtown Valley Road, Suite 201 Newburgh, PA 15840 717-865-1111 (P) 717-865-1111 (F)	STEVEN R. CATTANI 1000 WEST 10TH AVENUE, SUITE 100 DENVER, COLORADO 80202	BRETT W. SKAPINEZ 1000 WEST 10TH AVENUE, SUITE 100 DENVER, COLORADO 80202	LIGHTING PLAN 'C'	SHEET NO. 43 DATE: 11/17/23 DRAWN BY: [unintelligible]
	SHEET NO. 43 OF 43 DATE: 11/17/23 DRAWN BY: [unintelligible]	PROJECT: PAVING ASSOCIATES, LTD. 1000 WEST 10TH AVENUE, SUITE 100 DENVER, COLORADO 80202		DYNAMIC ENGINEERING 825 Newtown Valley Road, Suite 201 Newburgh, PA 15840 717-865-1111 (P) 717-865-1111 (F)	STEVEN R. CATTANI 1000 WEST 10TH AVENUE, SUITE 100 DENVER, COLORADO 80202	BRETT W. SKAPINEZ 1000 WEST 10TH AVENUE, SUITE 100 DENVER, COLORADO 80202	LIGHTING PLAN 'C'

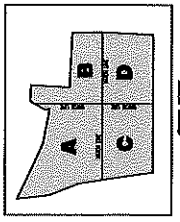
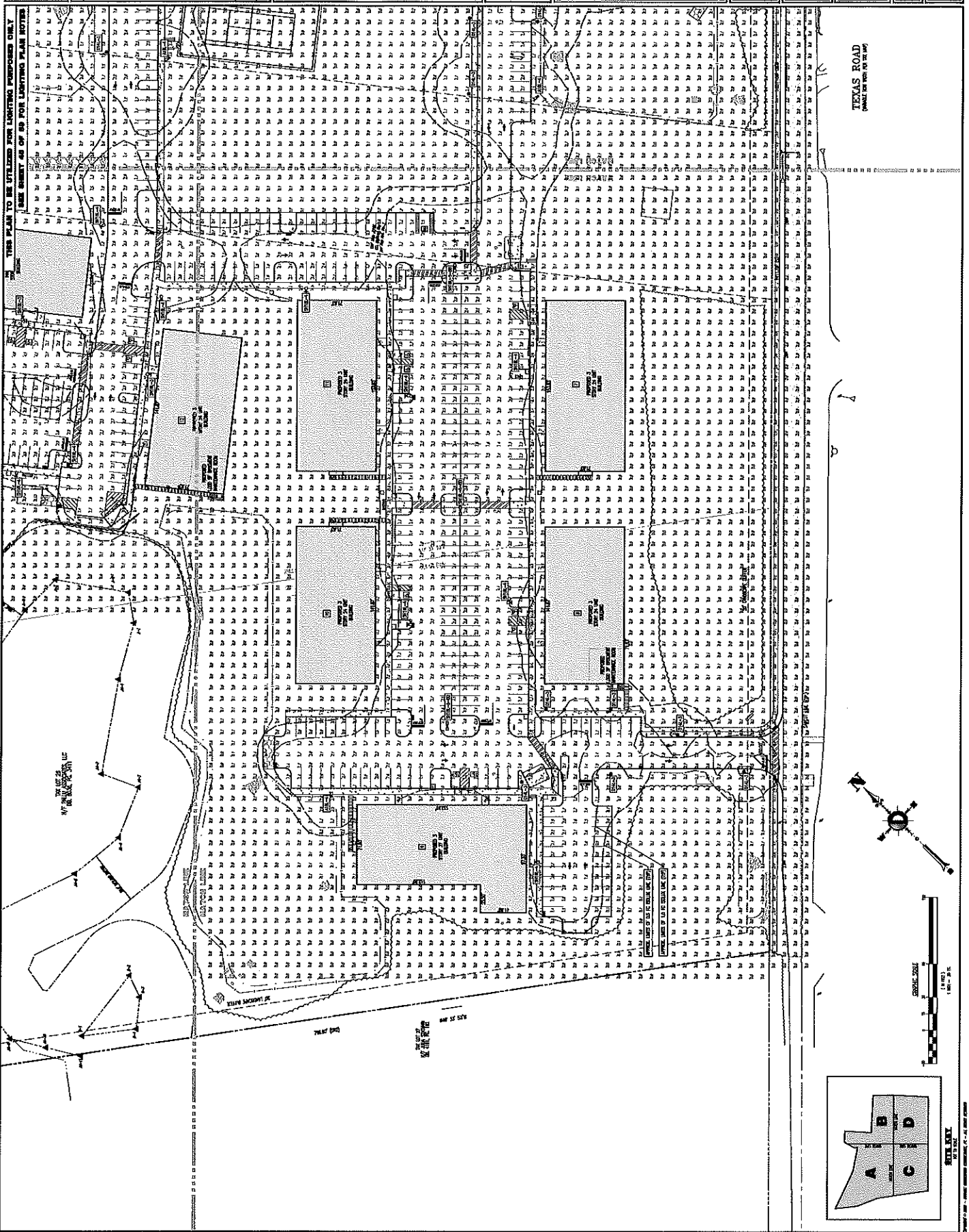



NO.	DATE	DESCRIPTION

THIS PLAN IS INTENDED FOR USE THROUGHOUT THE PROJECT. ANY CHANGES TO THIS PLAN SHALL BE MADE BY THE ENGINEER AND SHALL BE INDICATED BY A REVISION TABLE. THE CLIENT SHALL BE RESPONSIBLE FOR OBTAINING ALL NECESSARY PERMITS AND APPROVALS FROM THE APPROPRIATE AGENCIES. THE ENGINEER SHALL NOT BE RESPONSIBLE FOR THE ACCURACY OF THE DATA PROVIDED BY THE CLIENT OR FOR THE CONSTRUCTION OF THE PROJECT.

PALU ASSOCIATES, LTD.
 1000 WEST 10TH AVENUE, SUITE 100
 DENVER, COLORADO 80202
 (303) 733-1111

DYNAMIC ENGINEERING
 826 New York Avenue, N.W.
 Washington, D.C. 20004
 (202) 638-1111

STEVEN R. CATTANI
 PROFESSIONAL ENGINEER
 LICENSE NO. 117772

BRETT W. SARGENTZ
 PROFESSIONAL ENGINEER
 LICENSE NO. 117772

SOIL EROSION AND SEDIMENT CONTROL PLAN C

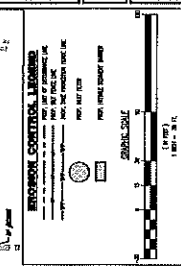
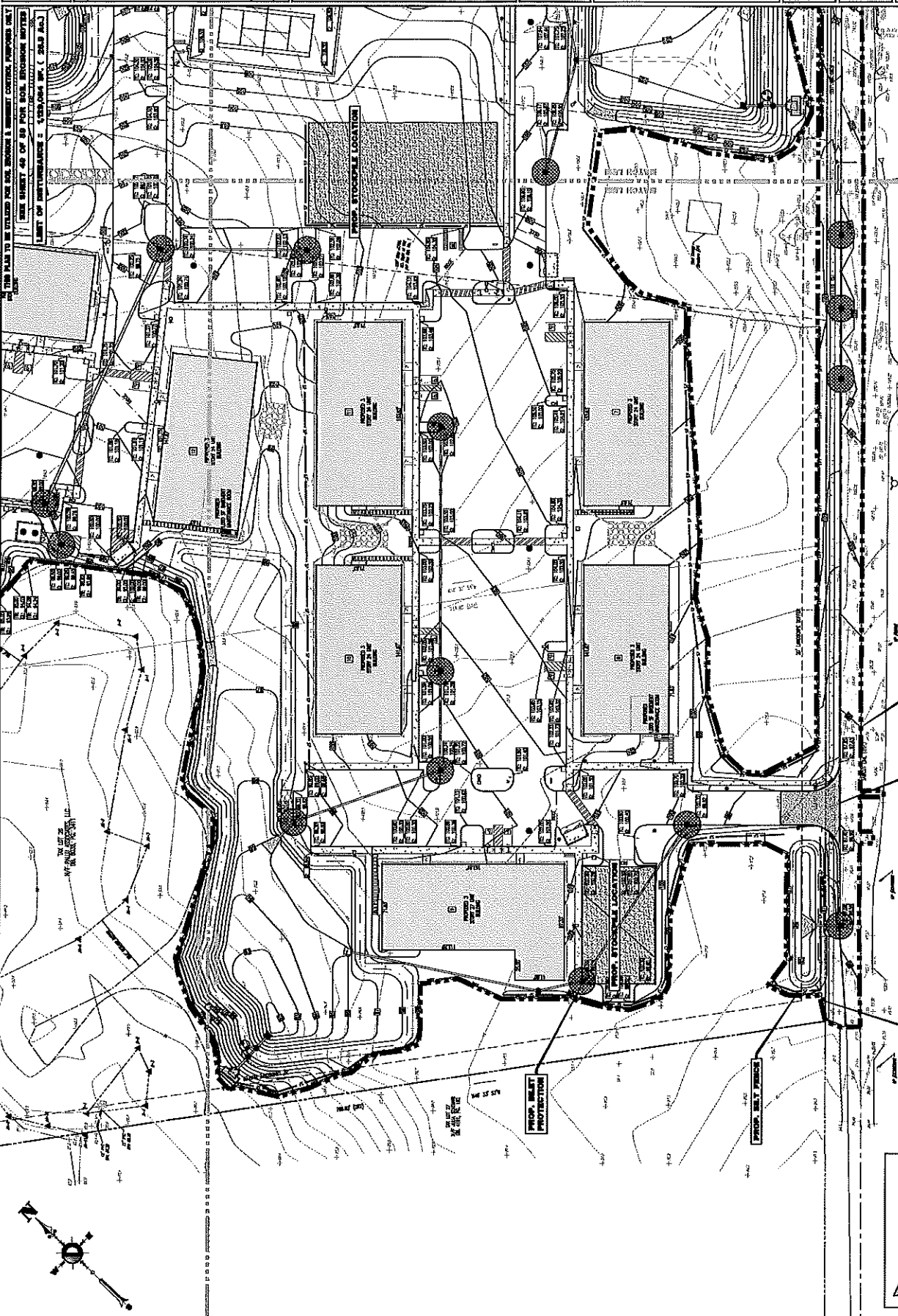

PROPOSED CONSTRUCTION SCHEDULE

DATE OF SUBMITTAL: 11/17/2011
 DATE OF PERMIT: 11/17/2011
 DATE OF CONSTRUCTION START: 11/17/2011
 DATE OF CONSTRUCTION END: 11/17/2011

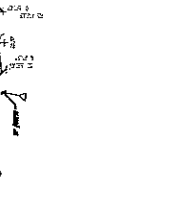

SOIL EROSION AND SEDIMENT CONTROL PLAN C

49

